

### Countertop Edge

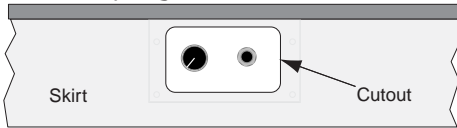

### SKIRT MOUNTING FOR -1 OR -3 PANELS:

Cut out a 3 5/8" x 2" beveled opening in the skirt. Place the panel against the rear of the skirt, center on the opening, and mark the four mounting holes. Drill four pilot holes. Fasten panel to the backside of the skirt using four 6/32 cabinet screws [customer-supplied].

### Countertop Edge Molding

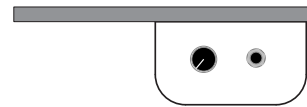

### FLANGE MOUNTING FOR -2 AND -4 PANELS:

Set the panel a few inches behind the edge molding on the countertop. Hold the panel in place and mark the four mounting holes. Drill pilot holes then mount the panel using four 6/32 cabinet screws [customer-supplied].

PRE99-1214-1  
HEADPHONE JACK,  
SKIRT MOUNT

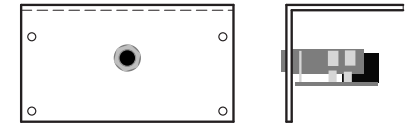

PRE99-1214-2  
HEADPHONE JACK  
FLANGE MOUNT

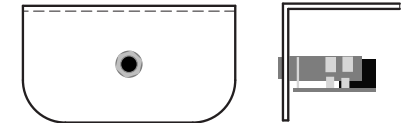

PRE99-1214-3  
H/P POT & JACK  
SKIRT MOUNT

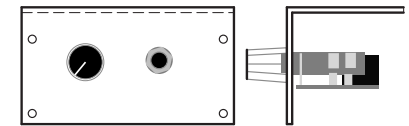

PRE99-1214-4  
H/P POT & JACK  
FLANGE MOUNT

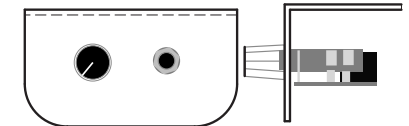

PRE99-1214-5  
H/P POT & JACKS  
(1/4" & 1/8")  
TURRET MOUNT

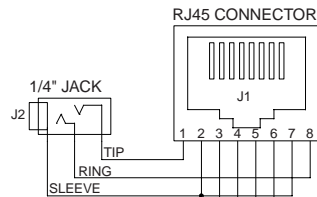
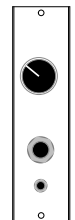

3-PIN MOD IV CONNECTOR

FADER WIPER	J4	3
FADER TOP	J4	2
FADER BOTTOM	J4	1

PRE99-1214-1, -2 SCHEMATIC

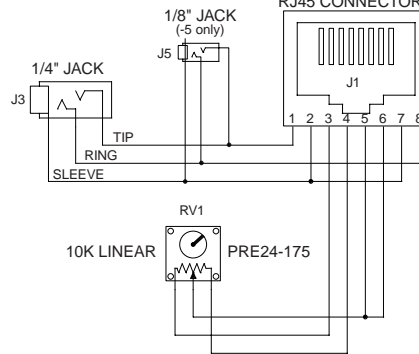

PRE99-1214-3, -4, -5 SCHEMATIC

### APPLICATION EXAMPLES

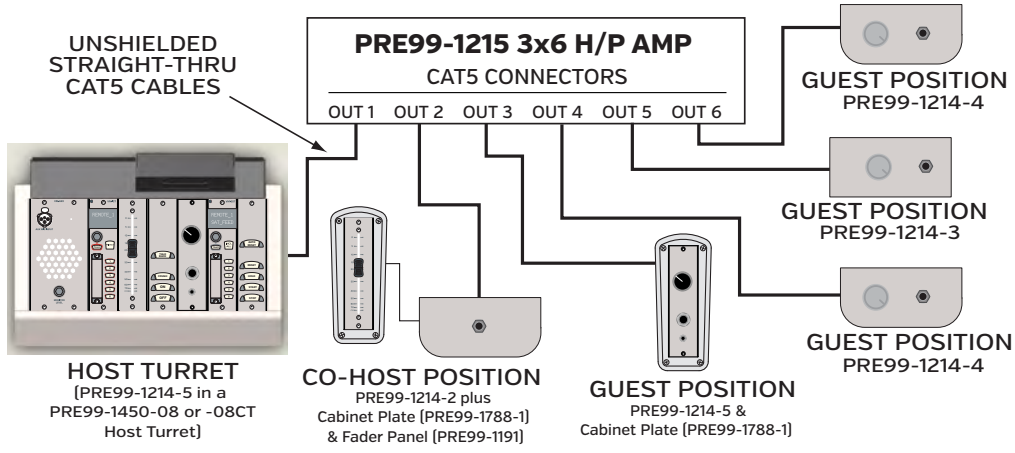

### PANEL INSTALLATION

1. Connect a straight-thru CAT5/CAT6 cable from J1 (RJ45) to an RJ45 output jack on the PRE99-1215 3x6 Headphone Amplifier.

2. On a PRE99-1214-1 or PRE99-1214-2 panel, a PRE99-1191 Fader Panel can be plugged into J4 to control the H/P level.

3. On the 3x6 HP amp, set Switches S1 and S2 to set the audio source (Host, Co-Host, Guest) and set whether the level control is active (Fader or Fixed) for each panel's output.

THIS DOCUMENT APPLIES TO  
PRE99-1214-1, -2, -3, -4, -5



PACIFIC RESEARCH &  
ENGINEERING

phone 1.252.638-7000  
pre.com | techsupport@wheatstone.com

DESIGNS BY PACIFIC RESEARCH & ENGINEERING

TITLE  
INSTRUCTION SHEET, HEADPHONE PANELS  
FOR PRE99-1215 3X6 HEADPHONE AMP

DRAWN  
RM  
SHEET  
1 OF 1

DATE  
Apr 5, 2016  
APVD.

DWG. NO.

71-1214

REV.

E